

● M30

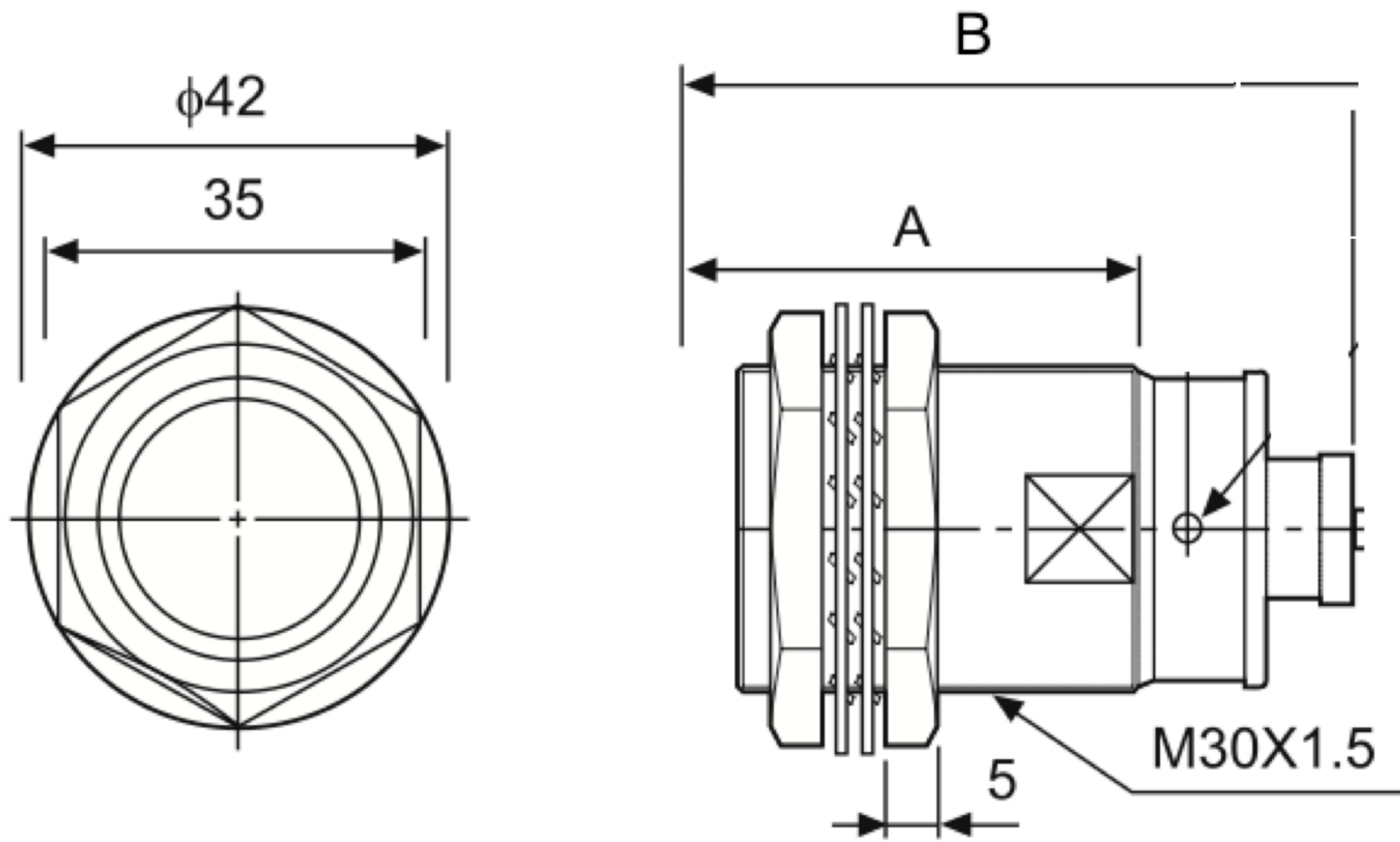

A = 46 mm  
B = 65 mm  
Diametro: 30 mm