

●M30

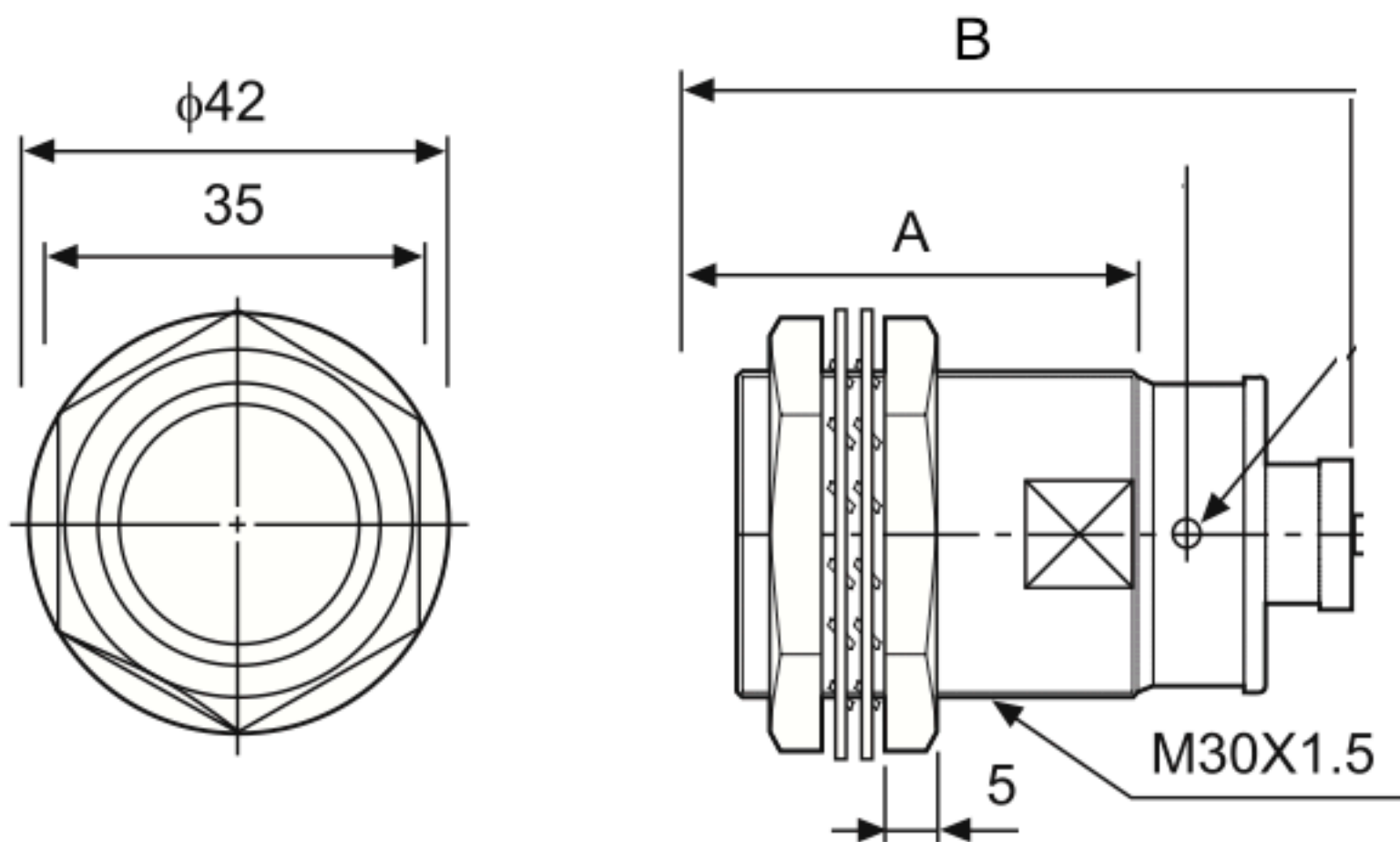

A = 50 mm
B = 80 mm
Diametro: 30 mm