

● M30

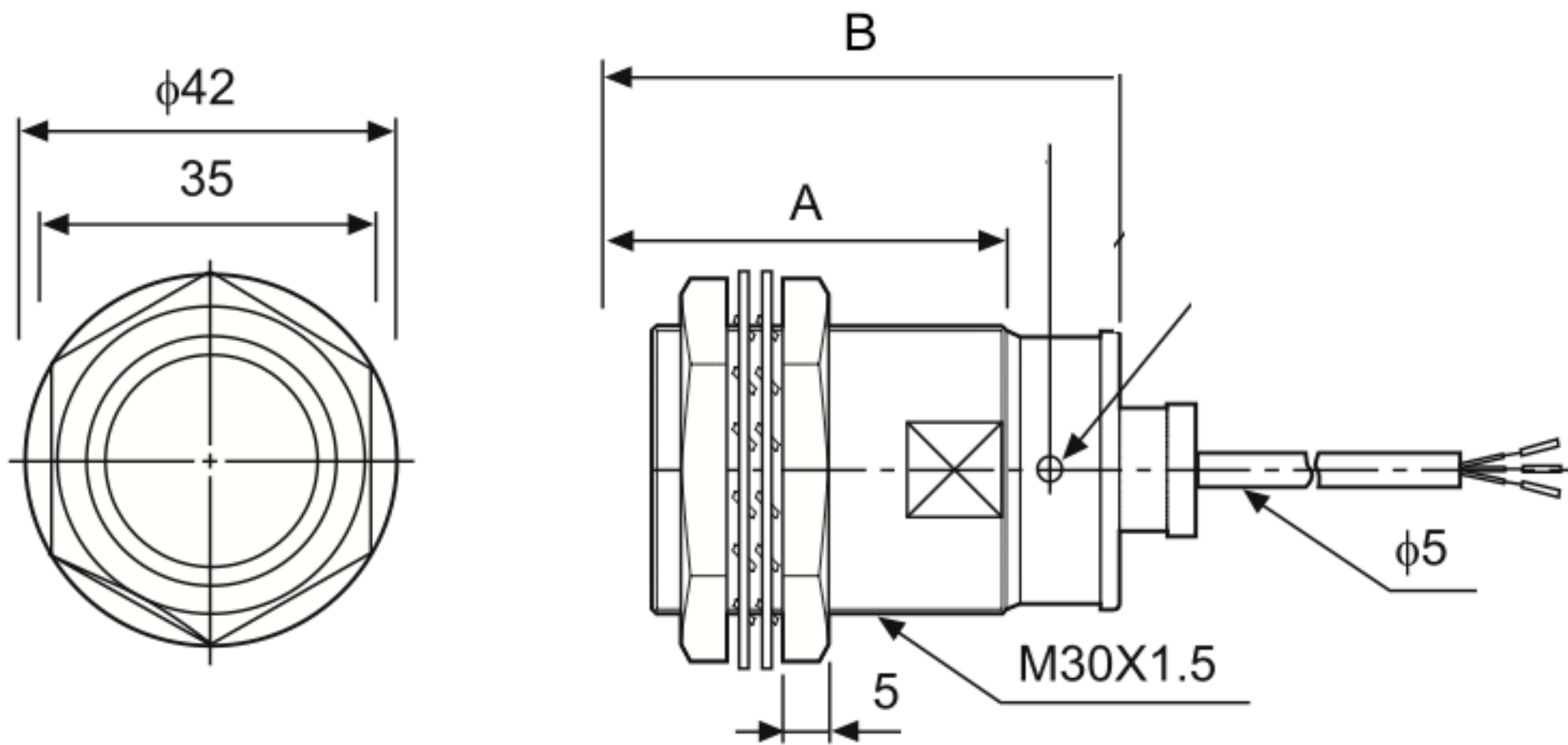

A = 50 mm
B = 56 mm
Diametro: 30 mm